



EXPO

SCHEDA TECNICA • TECHNICAL SHEET • FICHE TECHNIQUE

# Teca M Gastronomia

MODULAR • MAGNETIC

Model Reg. n. TO 2011/29 • TO 2016/92488

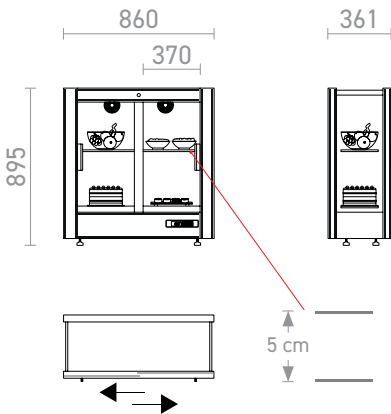

TMG-H20

CODE	USE	mm L x P x H	LT	Shelves	HFC	g HFC	LIGHT	dB	V	W	kg
TMG-H20	Professional	860 x 361 x 895	114	4	R 600 a	25	N	42	230 / 50-60 Hz	150	62

## POSSIBILI IMPOSTAZIONI • POSSIBLE SETTINGS • CHOIX DE RÉGLAGE

+8°C  
+6°C  
+4°C

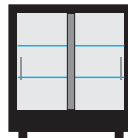

SET 4 °C  
TA 25°C

## IMBALLO • PACKAGING • EMBALLAGE

Dimensioni con imballo su pedana	Dimensions including packaging on pallet	Dimensions avec emballage sur palette	1000 x 800 x 1120
Peso con imballo su pedana	Weight including packaging on pallet	Poids avec emballage sur palette	80 Kg
Volume con imballo su pedana	Volume including packaging on pallet	Volume avec emballage sur palette	0,9 m <sup>3</sup>

Struttura in alluminio	Aluminium structure	Structure en aluminium
Cover in laminato / HPL	Laminate/HPL cover.	Cover en stratifié ou laminé haute pression/HPL
Porte scorrevoli, fianchi e top con vetrocamera - protezione UV	Sliding doors, sides and top in double glass - anti-UV protection	Portes coulissantes, les côtés et le dessus en double vitre - protection anti UV
Serratura con chiave	Lock with key	Serrure à clé
Interni in alluminio	Aluminium interior	Intérieur en aluminium
Refrigerazione statica e ventilata	Static and ventilated refrigeration	Réfrigération statique et ventilé
Termoregolatore digitale	Digital temperature controller	Thermorégulateur digital
Sbrinamento automatico ed evaporazione automatica della condensa	Automatic defrosting and automatic evaporation system	Dégivrage et évaporation de la condensation automatiques
Sistema di antivibrazione	Anti-vibration system	Système anti-vibration
Guida riscaldata	Heated rails	Rails chauffés
Compressore ad inverter	Inverter compressor	Compresseur onduleur
Illuminazione a LED: N = 4000 K - 30 led/mt - 7,2 W / mt - 572 lumen / mt	LED lighting: N = 4000 K - 30 led/mt - 7,2 W / mt - 572 lumen / mt	Éclairage led: N = 4000 K - 30 led/mt - 7,2 W / mt - 572 lumen / mt

UNITÀ REFRIGERANTE INTEGRATA • SELF-CONTAINED REFRIGERATING UNIT • UNITÉ RÉFRIGÉRANTE INTÉGRÉE

IMPIANTO A REFRIGERAZIONE POSTERIORE - CONDENSAZIONE STATICA  
 REAR COOLING SYSTEM - STATIC CONDENSATION  
 SYSTÈME DE RÉFRIGÉRATION ARRIÈRE - CONDENSATION STATIQUE

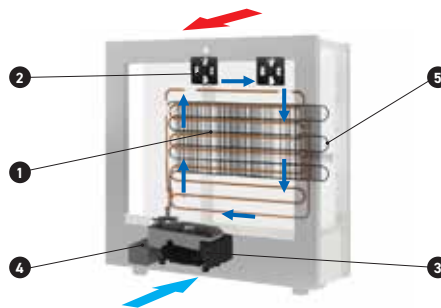
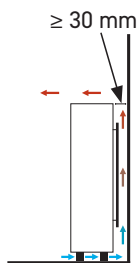







	circolazione aria interna inside air flow circulation de l'air interne
	aspirazione aria ambiente cold air suction aspiration de l'air ambiant
	espulsione aria calda warm air outlet expulsion de l'air chaud

La serpentina di raffreddamento ① e le ventole di aereazione interna ② sono posizionate all'interno del vano refrigerato dietro il pannello posteriore in alluminio. Il compressore ad inverter ③ e la vasca per l'evaporazione della condensa ④ sono inseriti nella base inferiore. Il condensatore statico ⑤ è installato nel retro della vetrina. Il raffreddamento del condensatore avviene per convezione senza l'ausilio di ventole. L'aria ambiente passa sotto la base e sale nello spazio tra il retro della vetrina ed il muro, si scalda ed esce dall'alto.

The cooling coil ① and the internal aeration fans ② are placed inside the refrigerated compartment, behind the aluminum back panel. The inverter compressor ③ and the evaporation pan ④ are placed in the lower base. The static condenser ⑤ is installed in the back of the cabinet. The condenser cools down due to convection without the use of fans. Ambient air comes through under the base and rises in the gap between the back of the cabinet and the wall, gets warm and exits from the top.

Le serpentin de refroidissement ① et les ventilateurs internes ② sont positionnés à l'intérieur du compartiment réfrigéré derrière le panneau du fond en aluminium. Le compresseur onduleur inverter ③ et le réservoir d'évaporateur de condense ④ sont insérés dans la base inférieure. Le condensateur statique ⑤ est installé à l'arrière de la vitrine. Le refroidissement du condenseur se fait par convection sans l'aide de ventilateurs. L'air passe sous la base et s'élève dans l'espace entre l'arrière de la vitrine et le mur, il se réchauffe et s'échappe vers l'haut.



-  Accende e spegne lo strumento • *Turn on and off the appliance* • Allume et éteinde l'appareil
-  Accende e spegne la luce • *Turn on and off the light* • Allume et éteinde l'éclairage
- SET** Per visualizzare/modificare Set point • *View/change the set point* • Pour afficher/changer le point de consigne
-  Per avviare sbrinamento manuale • *Start the manual defrost cycle* • Pour lancer le dégivrage manuel
-  Per diminuire la temperatura • *Decrease the temperature* • Pour diminuer la température
-  Per aumentare la temperatura • *Raise temperature* • Pour augmenter la température
- FLUX** Per attivare resistenza guide • *Switch on rails heating* • Pour activer le rechauffage du cadre des rails
-  Per attivare ventole interne • *Switch on inside fans* • Pour activer les ventilateurs interieurs

## COVER



TM2-H-



TM2-H-U-

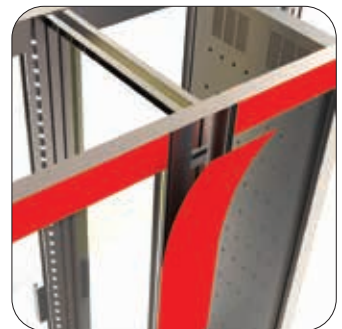
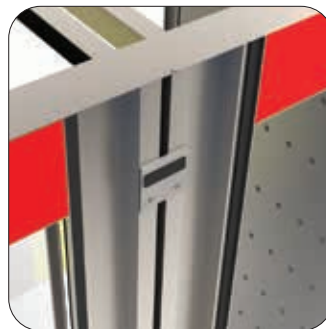

Le cover della Teca M sono costruite in laminato o HPL. Sono disponibili due cover (grandi e piccole) nelle tre versioni H/M/C.

*Teca M covers are made in laminate or HPL. Two types of cover are available (large and small) in the three H/M/C versions.*

*Les COVER de Teca M sont réalisés en stratifié ou en HPL. Elles sont disponibles en deux tailles (grande et petite) et dans le trois versions H / M / C.*

L'applicazione della Cover è magnetica. A richiesta la vetrina può essere fornita con Cover già applicata.

*The fixing of the cover is magnetic. On request Teca M can be supplied with the Covers already fixed.*

*L'application de la Cover est magnétique. Sur demande, la vitrine peut être fournie avec Cover déjà appliqué.*

Per unire due o più vetrine insieme occorre rimuovere i profili angolari ed avvitare le staffette fornite insieme alla Cover "- U".

*To join two or more Teca M units together, the corner profiles must be removed and it is necessary to screw the brackets supplied with the Cover "U"*

*Pour joindre deux ou plusieurs vitrines il faut supprimer les profils angulaires et visser les supports fournis avec la Cover "U".*

Applicare la Cover "- U" magnetica per coprire il punto d'unione, rifinire ed armonizzare la composizione.

*Fix the "U" magnetic Cover to hedge the juncture between the showcases, finishing and harmonizing the composition.*

*Appliquer la Cover "U" magnetique pour chacher et terminer le point d'union entre les vitrines.*